

Surface Drainage and  
Building Elements



**ACO SPORT**

*System 2000 Product Brochure*

**Slotted Track and Field Drainage System**



## System 2000

Sporting facilities use a wide variety of hard & soft surface materials. All external venues should incorporate surface drainage to protect these surfaces.

### Running Tracks

System 2000 is the premier slotted running track drain system, used at most high profile venues, including professional and IAAF stadiums. The system is supplied in straight and radiused channels with a matching in-line catch basin to provide a continuous run around the entire running track. Increased depth provides maximum hydraulic performance.



### System 2000 Channels

System 2000 channels are available in one meter (39.37") and half meter (19.69") lengths and designed for use where a smooth transition from running track to sport field is required.

System 2000 channels are ideal for use where synthetic track surface is used on both sides of the drain - such as 'D' areas and high jump areas.

### System 2000 Catch Basin

The System 2000 catch basin is an in-line outlet, placed at intervals throughout the trench run around the track. A removable polymer concrete cover provides easy access without detracting from overall aesthetics. Track material can be applied to cover for a totally discrete solution.

An optional plastic trash bucket fits inside the catch basin and acts as a sieve to collect debris washed into the system. Regular emptying and cleaning will help prevent pipe blockages and flooding.

The catch basin features drill-outs for 4" and 6" pipe connections, for an outlet pipe on one side (shown below) and for inlets, on reverse. Other size pipes can be connected by custom cutting using a core-drill.





**Smooth, flat top surface** - provides an excellent surface to glue carpet style track surfacing to.



**Drainage slot** - 0.5" (12.7mm) drainage slot offset from the center. ADA compliant.

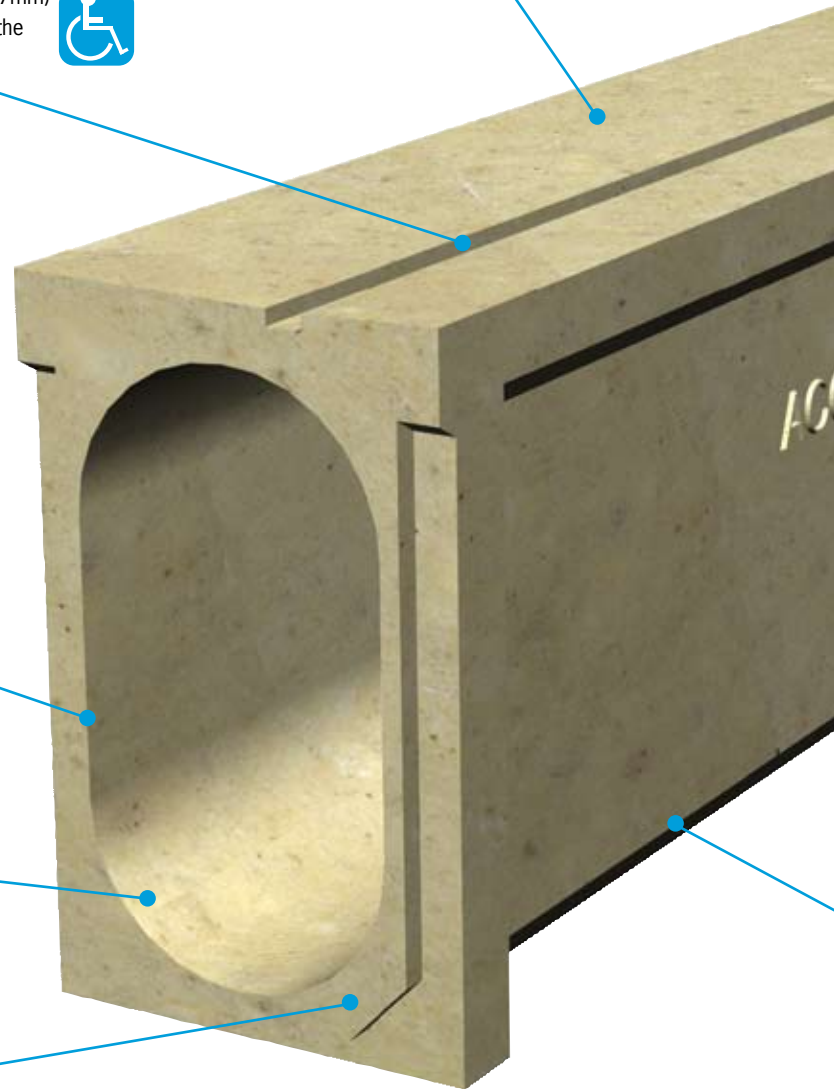

**Hydraulic performance** - 8.8" (224mm) invert depth offers excellent hydraulics.

**U-shaped profile** - offers excellent hydraulic performance.

**Interconnecting profiles** - male/female end details allows easy and effective joining of channels.

**Slot bridge** - prevents slot closing due to pressure during concrete pour. Each channel has bridges located centrally, and at each end.

**Polymer concrete** - durable, yet lightweight, material made from polyester resin binder reinforced by mineral aggregates and fillers. Provides up to four times the compressive strength of cement concrete and almost twice the compressive strength of HDPE. Offers a thermal expansion ratio similar to the concrete surround, particularly important where long runs are used to prevent 'buckling.'

**Direction arrows** - arrows point from female end towards male end of channel. For track use these normally point clockwise around the track when viewed from inside the track. For radius channels this is critical to ensure radius is oriented correctly.

**Channels** - one meter (39.37") straight or radius and half meter (19.69") straight channels available to enable continuous drainage around entire 400 meter track.

**Neutral depth** - channels are supplied in neutral depths. This makes installation simple and provides ample hydraulics for the majority of track applications.



# ACO SPORT

	Part No	Length in (mm)	Overall Depth in (mm)	Weight lbs
<b>System 2000 Channels</b>				
Straight	00784	39.37 (1000)	9.8 (249)	66.0
Straight	97487	19.69 (500)	9.8 (249)	33.0
Radius	00786	39.37 (1000)	9.8 (249)	66.0
<b>In-line Catch Basin</b>				
Catch basin	05620	19.69 (500)	23.0 (585)	57.0
Polymer concrete cover	00788	19.69 (500)	0.8 (20)	9.0
Plastic trash bucket	01498	17.6 (448)	-	1.1
6" oval-to-round adapter	95140	-	-	1.1

## One meter channel

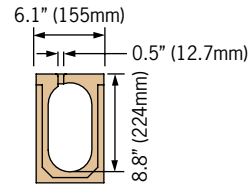
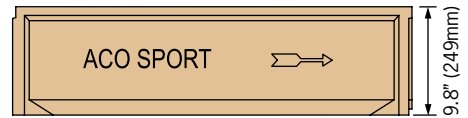
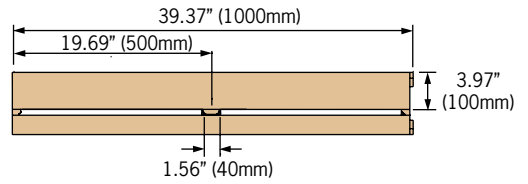

## Half meter channel

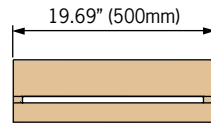

## Catch basin cover

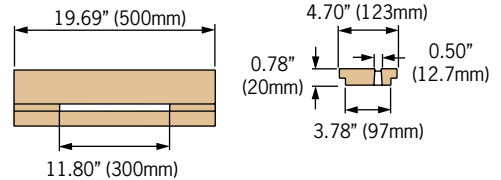

## Catch Basin Flow Rates

Outlet	Outlet Size	Invert Depth	GPM	CFS
A	4" Sch 40	12.60"	175	0.40
B	6" Sch 40	12.60"	379	0.87
C	6" Sch 40	21.63"	530	1.22
D	4" Sch 40	21.63"	242	0.54
E	6" oval	21.63"	372	0.86

## In-line catch basin

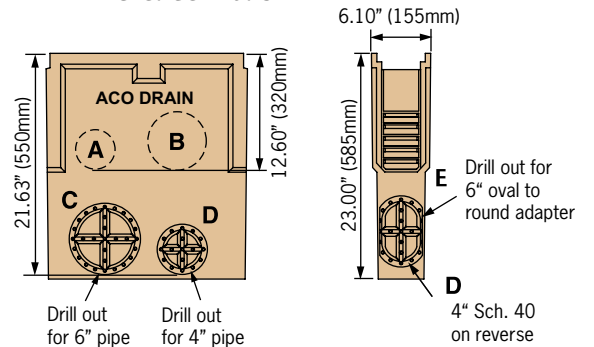



## Other ACO SPORT systems

- **System 1000**  
The premier running track drain system with canopy cover.
- **System 3000**  
The economical, general purpose running track slot drain system used by colleges and schools.
- **System 4000**  
An open channel drain with removable grates. Ideal for tennis courts and general sport field use.
- **System 6000**  
The premier open channel drain system with synthetic turf clamping device.
- **System 7000**  
Sand traps and rubber capped curbs to fit around sand pits used for long jump and high jump.
- **System 8000**  
A series of accessories for water jump, pole vault and throwing disciplines.
- **System 9000**  
A simple polymer concrete stadium terracing and seating system for college and school facilities.

### ACO Polymer Products, Inc.

#### East Sales Office

P.O. Box 245  
Chardon, OH 44024  
Tel: (440) 285-7000  
Toll free: (800) 543-4764  
Fax: (440) 285-7005

#### West Sales Office

P.O. Box 12067  
Casa Grande, AZ 85230  
Tel: (520) 421-9988  
Toll Free: (888) 490-9552  
Fax: (520) 421-9899

#### Electronic Contact:

info@acousa.com  
www.acousa.com



© July 2007 ACO Polymer Products, Inc.

All reasonable care has been taken in compiling the information in this document. All recommendations and suggestions on the use of ACO products are made without guarantee since the conditions of use are beyond the control of the Company. It is the customer's responsibility to ensure that each product is fit for its intended purpose and that the actual conditions of use are suitable. ACO Polymer Products, Inc. reserves the right to change products and specifications without notice.

Re-order Part # AS004